

Duikkraboard

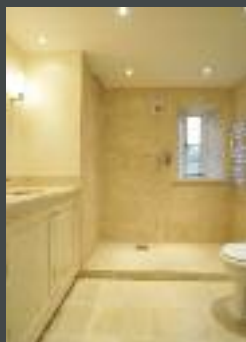

Dukkaboard® the experience begins...



©Dukkaboard 2009
Issue: 01/09
Printed in England

contents

An Introduction to Dukkaboard	2-3
How to Fix Dukkaboard	4-27
Stud Walls – Metal or Timber Studs	4-5
Solid Walls – Masonry	6-7
Straight Partition Walls – Dukkaboard	8-9
Curved Partition Walls – Dukkaboard Creative	10-11
Half Tiled Walls	12-13
Damaged Walls	14-15
Timber Floors	16-17
Solid Floors	18-19
Shower Trays – Timber Floor	20-21
Shower Trays – Solid Floor	22-23
Boxing	24-25
Underfloor Heating	26-27
How to Waterproof Dukkaboard	28-32
Walls, Floors	29
Pipes	30
Joints, Washers	31
Corners	32
Dukkaboard Specifications	33-34
Building Panels	33
Construct	33
Made-to-Measure Shower Trays	33
Creative	34
Accessories	34
Fixing Details	35
Cutting Methods	36
Dukkaboard Technical Details	36

The Dukkaboard® tile backing and waterproofing system



Dukkaboard®
Flat panels for walls and floors in a range of thicknesses.



Dukkaboard® Construct
Pre-formed shower trays in a range of shapes and sizes. Round and spiral shower kits.



Dukkaboard® Creative
Pre-scored panels for curved walls, partitions and columns.

Accessories

You will also need these accessories when working with Dukkaboard systems:



Fixing washers



Fixing brackets



Fixing screws

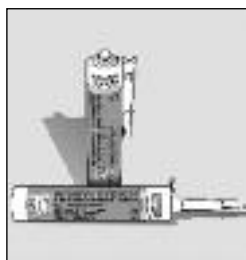

Purocol adhesive



Stainless steel dowels

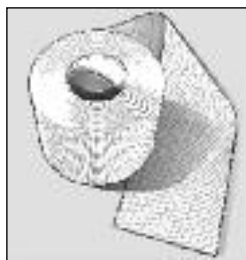

Reinforcement tape

Waterproofing

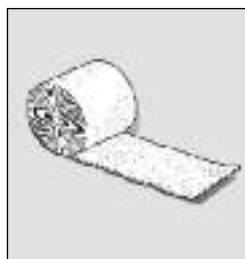

Mira Safecoat roll



Mira Multicoat

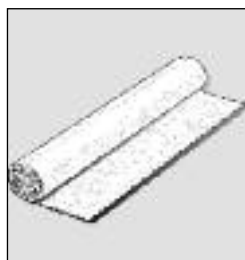

Mira Safecoat 1m wide

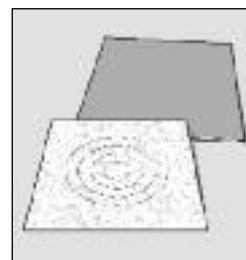

Mira manchet – large



Mira sealer

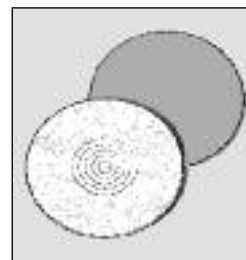

Mira manchet – small

Only imagination can limit the use of Dukkaboard®

The Dukkaboard® tile backerboard system is made up of three product ranges – flat panels, shower trays and Creative panels, supported by a comprehensive range of accessories and waterproofing products.

Dukkaboard® panels are manufactured using a high-density extruded polystyrene core with a polymer modified, glass fibre reinforced cement coating on both sides, which adds rigidity and strength to the board and shower trays.

Using Dukkaboard® and accessories quickly creates an ideal substrate for thin or thick-bed tile adhesive or render finishes to walls and floors.

The tanking system used by Dukkaboard® is a Danish product well known for its quality and dependability.

Moisture and rot proof

Ideal for bathrooms, showers and wetrooms. Suitable for exterior use.

Exceptional stability

Eliminates the common causes of tile failure associated with mdf, chipboard, plywood, plaster and plasterboard.

High thermal insulation

Helps reduce heat loss. Suitable and recommended for use with all types of electrical underfloor heating.

Lightweight and workable

Easier and faster to work with than all other types of building board.

Replaces wet finishes

Can be used in place of floor screeds and rendered/plastered wall finishes. Fast tracks tiling and saves costs.

Design

Unique and creative tiling design features are easy to add to any project.

How to fix Dukkaboard® stud walls

Traditionally, stud walls have been lined with plasterboard, taped and jointed, then skimmed with finish plaster. This creates a substrate unsuitable for areas prone to dampness and is a time-consuming job involving a number of tradesmen. Using **Dukkaboard®** panels the same can be achieved quickly and easily by one person creating an impervious substrate ready to be tiled.

- 1** Fix the studwork with centres appropriate for the thickness of the board and weight of tiles to be used. Screw the boards, using the correct number of fixing washers and drywall screws through to the studwork behind. **See fig 1.** The thicker the boards the better the thermal insulation.
- 2** When fixing the boards, all joints should be supported by a stud. Always make any cuts for pipes before fixing.
- 3** When all the boards are securely fixed to the studwork apply joint reinforcement tape before commencing the tiling work.

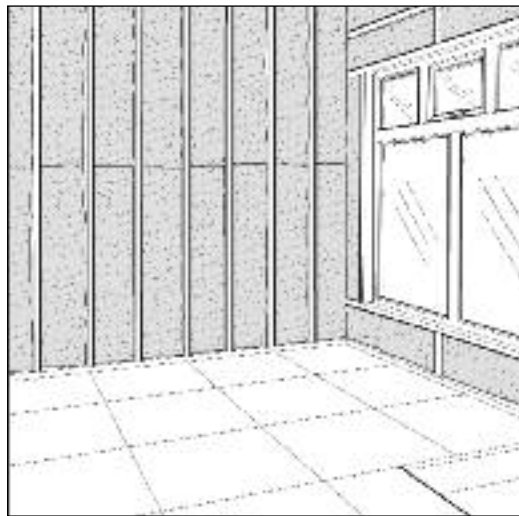

before installation



fig 1, installation

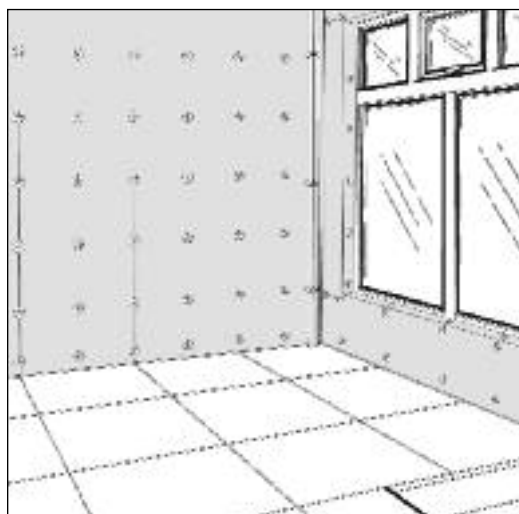

after installation



How to fix Dukkaboard® solid walls

When fixing *Dukkaboard*® to solid walls, possibly over the top of damaged plaster, you should use a mechanical fixing as well as adhesive. This will ensure a secure fixing into the brickwork behind any unstable plaster.

- 1 Using a bradawl, pierce the board right through to the other side to mark the position of the adhesive. **See fig 1.**
- 2 Place a trowel-size dab of flexible, cement-based tile adhesive on each hole. **See fig 2.**
- 3 Offer the *Dukkaboard*® up to the wall making sure it is upright. **See fig 3.**

- 4 Tamp the panel into position using a spirit level or straight edge, making sure each board lines up with the previous one. **See fig 4.**

- 5 When all the boards are in place and the adhesive has dried, drill an 8mm hole through the board at the bradawl holes into the sound substrate behind. **See fig 5.**

- 6 Insert a stainless-steel dowel into the holes and hammer home until the head has sunk slightly into the surface of the board. Too far will distort the head and make tiling difficult. **See figs 6 and 7.**

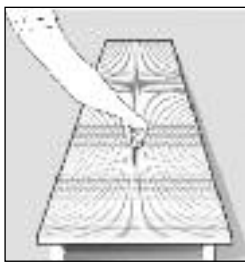

fig 1



fig 2

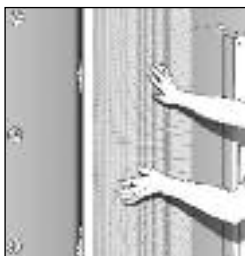

fig 3

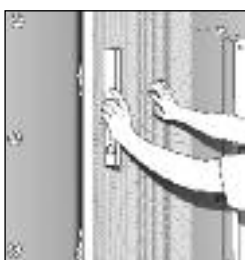

fig 4

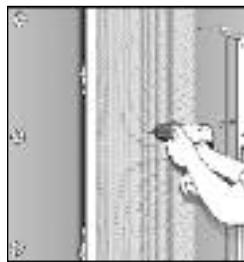

fig 5

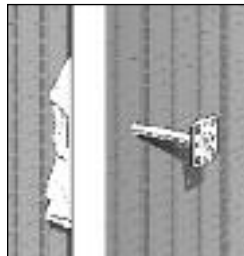

fig 6

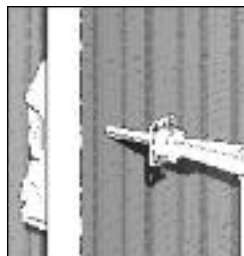

fig 7



stainless-steel dowel



How to fix Dukkaboard® partition walls

50mm *Dukkaboard*® panels provide an instant partition wall. This saves many hours of labour costs compared to the installation of traditional materials. It also creates a substrate that is impervious to moisture, strong and perfect for tiling on to.

1 Clearly mark out exactly where the partition wall is to be erected and fix the U brackets to the existing wall and to the floor. **See fig 1.**

2 Run a bead of Purocol adhesive down the edge of the panel and to the wall and floor where the first panel will connect.

Place the panel into the U brackets making sure it is perfectly vertical.

See fig 2.

3 Push the H brackets on to the edge of the first panel. **See fig 3**

4 Run a bead of Purocol adhesive down the edge and the edge of the next board.

See fig 4

5 Push the next board onto the first one making sure good contact is made with the Purocol adhesive. Repeat this method until the wall is complete. **See fig 5.**

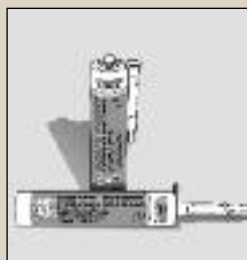

Purocol adhesive

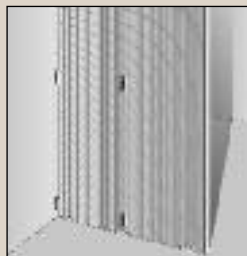

Example of a completed installation

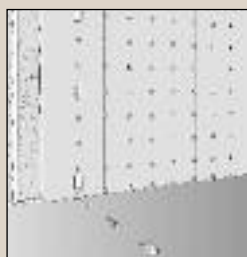

fig 1



fig 2



fig 3



fig 4

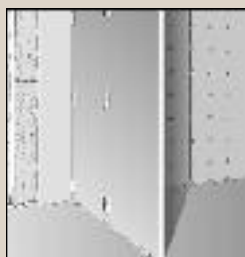

fig 5



How to fix Dukkaboard® curved partition walls

Dukkaboard® Creative pre-scored panels can be used to create curved partition walls, bath panels, reception desks, round and snail shaped shower cubicles and any other shaped object. This eliminates the time-consuming need for studwork, shaping and twisting of ply and plasterboard.

Dukkaboard® Creative is available in 30mm and 50mm thicknesses as standard with the option of laminating two or more pieces together so that any thickness required can be achieved.

- 1 To create a partition wall with *Dukkaboard® Creative*, use the same method as if building a straight wall (as described on page 8), however, extra reinforcement will be needed once the Purocol adhesive has dried. Apply the adhesive to the inner side of the curve. **See fig 1.**
- 2 Apply 1m wide reinforcement tape to the wet adhesive and skim over the whole area with a trowel. **See fig 2.**
- 3 Application of the reinforcement tape should extend round the edges of the board onto the polystyrene. **See fig 3.**



fig 1

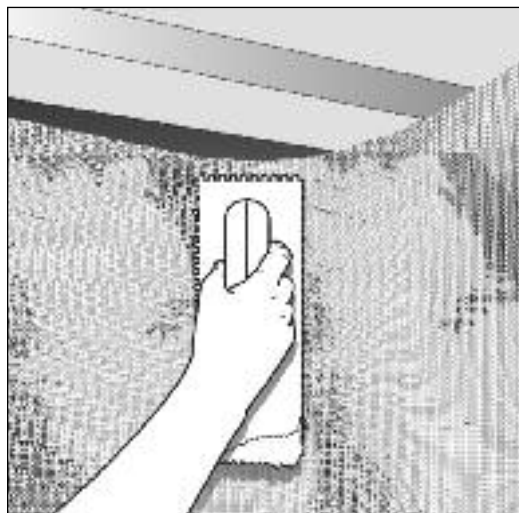

fig 2

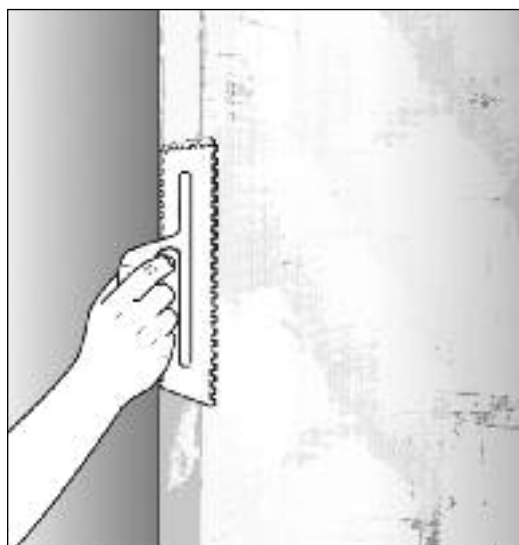

fig 3



Example of a completed installation



Reinforcement mesh



How to fix Dukkaboard® half tiled walls

When a room has been tiled only to half height or perhaps just around the bath area it is not always practical to remove the tiles due to the damage this will cause to the plasterboard underneath.

Dukkaboard® can be used to fill out the areas around the tiles to bring both surfaces level.

- 1** Decide exactly which areas are going to be tiled and apply the tile adhesive with a 6mm notched trowel. If the area is particularly uneven use an 8mm or 10mm notched trowel. **See fig 1.**
- 2** Using the correct thickness of *Dukkaboard*® (this depends on the thickness of the existing tiles), apply *Dukkaboard*® to the adhesive making sure full contact is made. **See fig 2.**
- 3** Align *Dukkaboard*® with the face of the surrounding tiles using a straight edge. **See fig 3.**
- 4** If the surface to be faced with *Dukkaboard*® is unsound, use either the dab and dowel method as used on solid walls, or fix with screws and fixing washers as used on studwork.

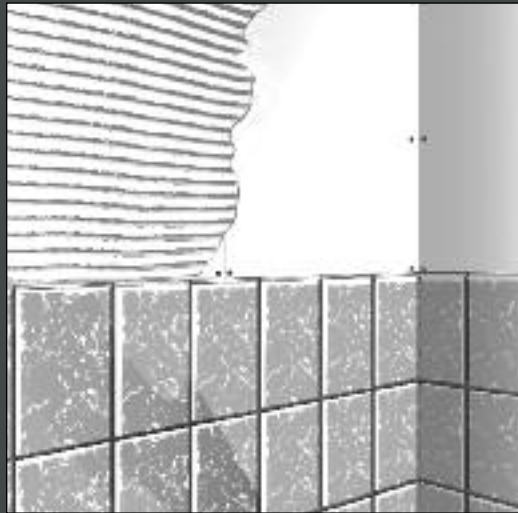

fig 1

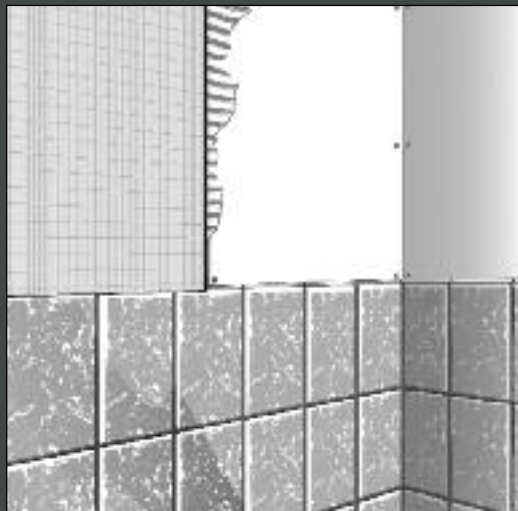

fig 2



fig 3



How to fix Dukkaboard® damaged walls

Removing old tiles from plaster and plasterboard invariably causes extensive damage. To re-plaster or replace sheets of plasterboard could mean complicated refurbishment involving the removal of sanitaryware and other items. Instead, *Dukkaboard*® can be used to reface the walls using the dab and dowel method or using screws and fixing washers into the substrate behind.

- 1 Remove all the old tiles leaving behind the old adhesive and plaster or plasterboard. Scrape off any loose material and clear away. **See fig 1.**
- 2 Cut the *Dukkaboard*® to size and fix to the walls as shown using the required method (as described on pages 4–8). **See fig 2.**
- 3 The project illustrated here was studwork, so screws and fixing washers were used. When complete, use joint reinforcement tape. The area is now ready to be tiled. **See fig 3.**



fig 1

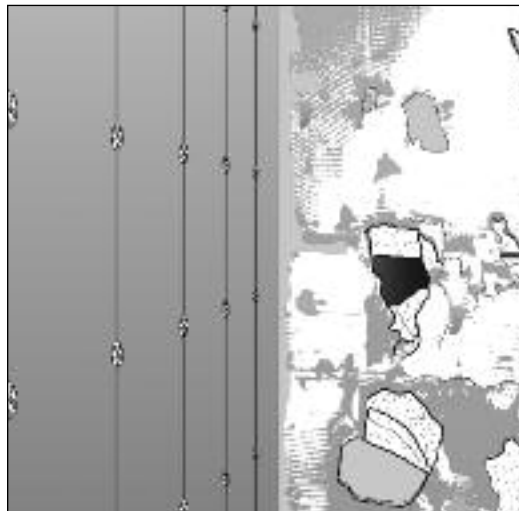

fig 2

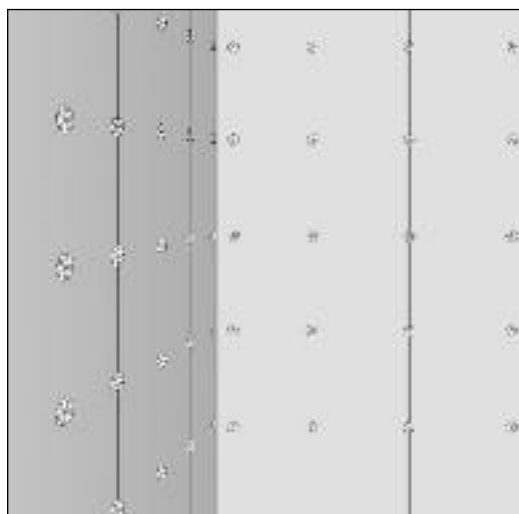

fig 3



How to fix Dukkaboard® timber floors

When fixing tiles onto a timber floor it will generally need strengthening. This can be done using a minimum thickness of 10mm *Dukkaboard*®, which should be fixed with either flexible cement-based tile adhesive or screws with fixing washers at 300mm centres.

When under-floor heating is being installed, 12mm *Dukkaboard*® is recommended for its superior thermal properties.

1 When fixing *Dukkaboard*® with screws and fixing washers the correct length of screws should be used to avoid damage to any underlying pipe work. When fixing with adhesive make sure the area is free of dust and use a suitable primer first.

See fig 1.

2 Each row of *Dukkaboard*® should be laid with staggered joints and butted together.

See fig 2.

3 When installed, use joint reinforcement tape on all joints before tiling.

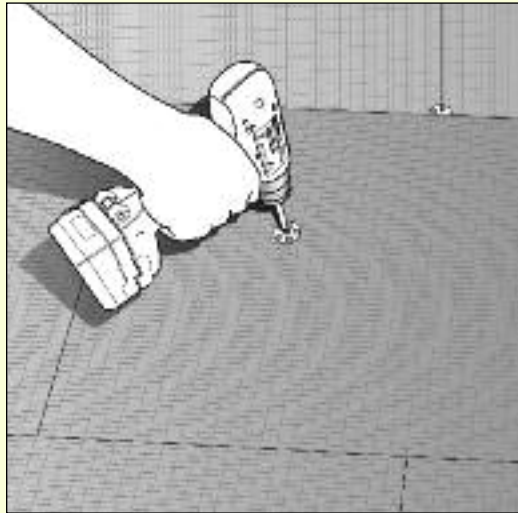

fig 1

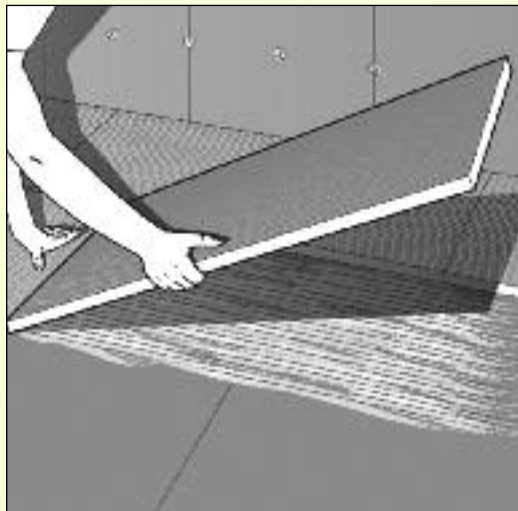

fig 2



How to fix Dukkaboard® solid floors

Before fixing *Dukkaboard*® to any floor make sure it is free from dust or any loose materials. Always treat the floor with a suitable primer to ensure good adhesion. Solid concrete floors transmit the cold and dampness from below so *Dukkaboard*® should be used before tiling for its excellent thermal properties. It is particularly beneficial when under-floor heating is being installed.

- 1 Using an 8mm or 10mm notched trowel, apply the cement-based, flexible tile adhesive to the prepared floor. Lay the first sheet onto the adhesive with a tamping motion to ensure complete contact is made. This will eliminate any voids. **See fig 1.**
- 2 Continue across the floor working backwards and staggering the joints. Make sure each board is perfectly level with the previous one. **See fig 2.**
- 3 Always cut the panels as accurately as possible around objects such as doorframes. When you have finished, allow the adhesive to dry before using joint reinforcement tape.

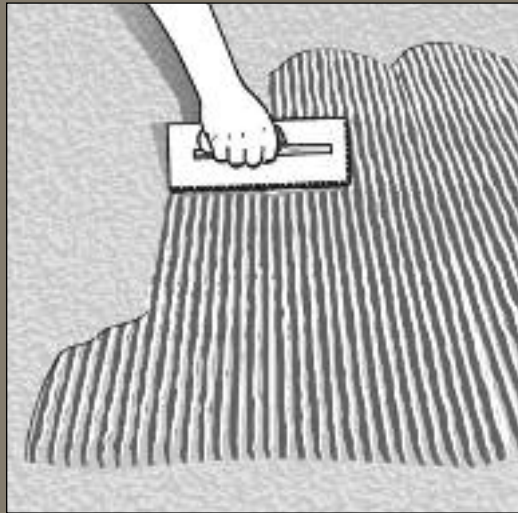

fig 1

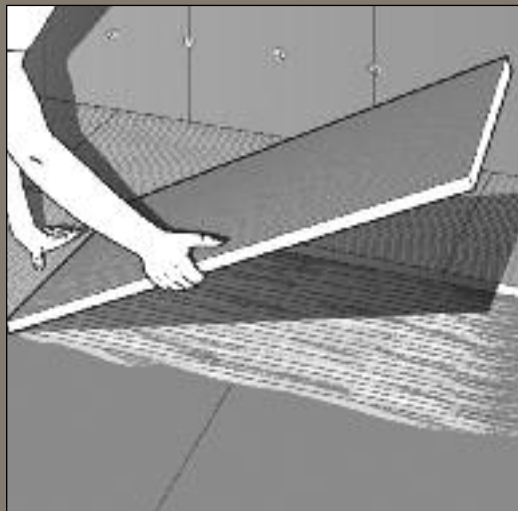

fig 2



How to fix Dukkaboard® shower trays *timber floor*

1 Cut out the required section of flooring.
See fig 1.



fig 1

2 Build a support for the drain body exactly 80mm below the surface of the surrounding floor. **See fig 2.**

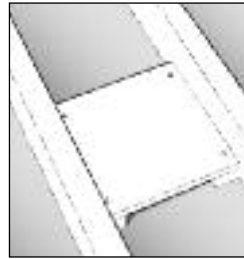

fig 2

3 Fix a batten 18mm (or the depth of the flooring used) below the top of the joists.
See fig 3.



fig 3

4 Connect the drain body to a 50mm BS standard waste pipe with solvent weld in the usual way. (Always check for leaks before final installation of the *Dukkaboard®* tray). Cut the timber to fit between the joists and screw on to the new battens which must be securely fixed to the sides of the joists. **See fig 4.**

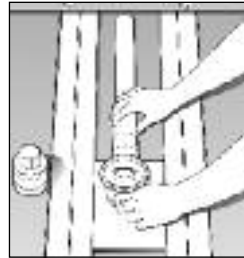

fig 4

5 The middle section needs a keyhole shape cut out for the waste. **See fig 5.**

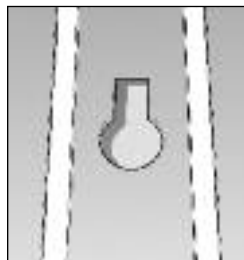

fig 5

6 This should be 10mm bigger than the drain body. **See fig 6.**

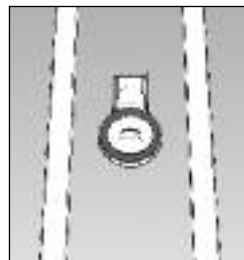

fig 6

7 Using a 10mm notched trowel apply the flexible, cement-based tile adhesive to the floor then fix the shower tray in place using a tamping motion to ensure no voids remain underneath. **See fig 7.**



fig 7

8 Screw the upper section of the drain body into the lower section through the tray, being careful not to disturb the tray. Realign as necessary. **See fig 8.**



fig 8

9 Build up the surrounding floor area with the correct thickness of *Dukkaboard®* as required using flexible, cement-based tile adhesive. **See fig 9.**

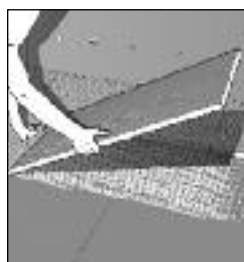
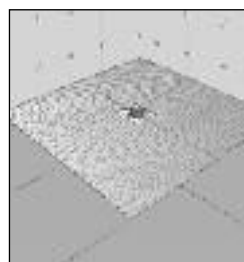

fig 9



Completed shower tray



How to fix Dukkaboard® shower trays *solid floor*

1 Cut a channel deep enough to take a BS standard 50mm pipe along the floor from the position of the drain body to a suitable exit point. **See fig 1.**

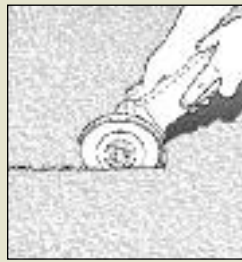

fig 1

2 The cut-out for the drain body needs to be 200mm square and 80mm deep. **See fig 2.**

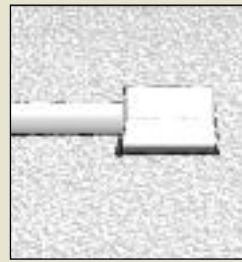

fig 2

3 Connect the drain body to the 50mm outlet with solvent weld in the usual way. We recommend that you use the plastic cap (as illustrated in fig 6) at this stage as a means to prevent dirt entering the drain body. (Always check for leaks before final installation of the *Dukkaboard®* shower tray). **See fig 3.**

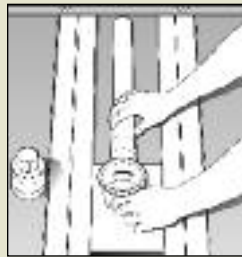

fig 3

4 Install the connected drain body and pipe into the channel and support with mortar at the correct height and fall. (The top of the drain body including the washer should be level with the surrounding floor). **See fig 4.**

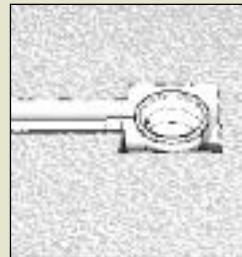

fig 4

5 Using a 10mm notched trowel apply the cement-based, flexible tile adhesive to the floor and lay the tray in place using a tamping motion to ensure no voids remain under the tray. **See fig 5.**

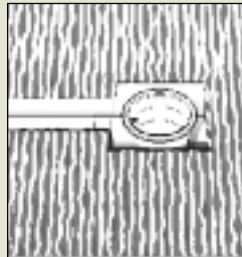

fig 5

6 Using the plastic cap, screw the upper section of the drain body into the lower section through the tray. Care should be taken not to disturb the tray, but realign if necessary. **See fig 6.**



fig 6

7 Build up the surrounding floor area with the correct thickness of *Dukkaboard®* as required using flexible, cement-based tile adhesive. **See fig 7.**

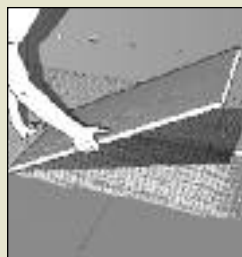

fig 7



Completed installation



How to fix Dukkaboard® boxing

Baths and pipes can be boxed in quickly and easily using 30mm *Dukkaboard*®. This eliminates the need for timber battens and studwork. Complete box systems can be made creating a strong and waterproof substrate ready for tiling.

- 1 Cut two pieces of *Dukkaboard*® to match the desired size of box. Run a bead of Purocol adhesive down the two edges that are to be stuck together. **See fig 1.**
- 2 Join up and leave until cured. **See fig 2.**
- 3 Run a bead of Purocol adhesive down the outside edges of the completed box section and push firmly into position. **See fig 3.**

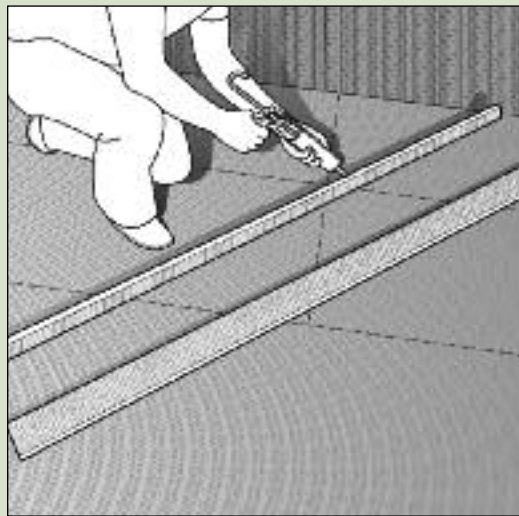

fig 1

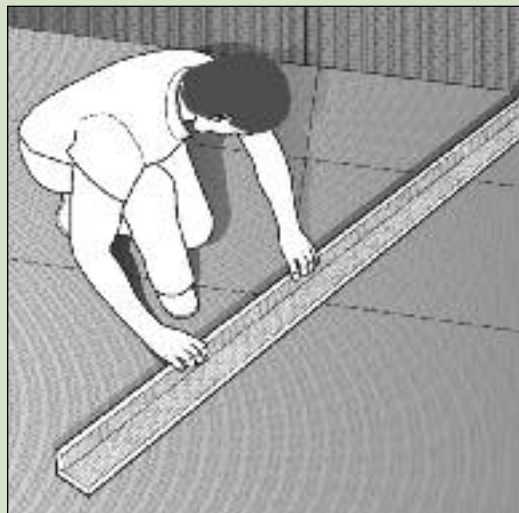
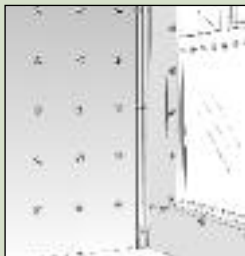

fig 2



Before installation

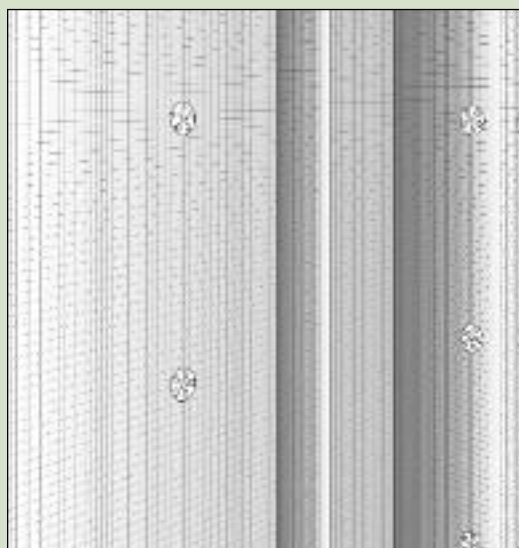
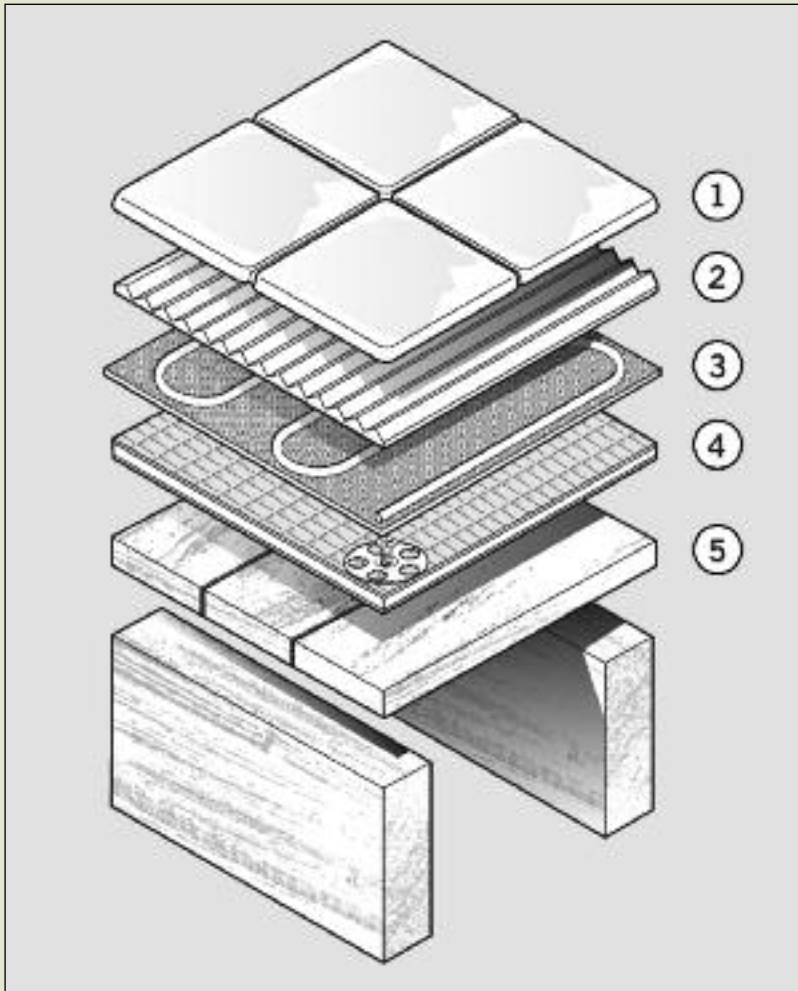

fig 3



How to fix Dukkaboard® underfloor heating

Using *Dukkaboard*® with underfloor heating will reduce the running costs and shorten warm-up times. We recommend that *Dukkaboard*® should be a minimum of 10mm thick to be suitable for thermal insulation and to create a stable substrate for tiling. In some cases 6mm thick *Dukkaboard*® can be used – please ask our technical department for details.



- 1 Finished floor covering (all types of ceramic and natural stone)
- 2 Flexible C2 tile adhesive
- 3 Underfloor Heating
- 4 *Dukkaboard*®
- 5 Substrate (can be solid or timber)



How to waterproof Dukkaboard®

Dukkaboard® and Mira create the ultimate waterproofing system, for total peace of mind.

The area needing to be tanked in a bathroom with a shower attachment consists of:

- the total floor area
- the wall to ceiling height around the bath, plus 50cm
- a 10cm upstand all the way round the walls

See fig 1.

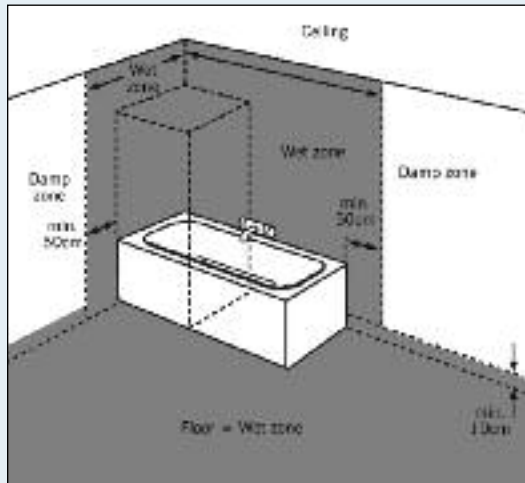

fig 1

The area needing to be tanked in a shower consists of:

- the total floor area
- the bottom 10cm of walls
- the area inside the shower enclosure, which should be covered up to the ceiling

See fig 2.

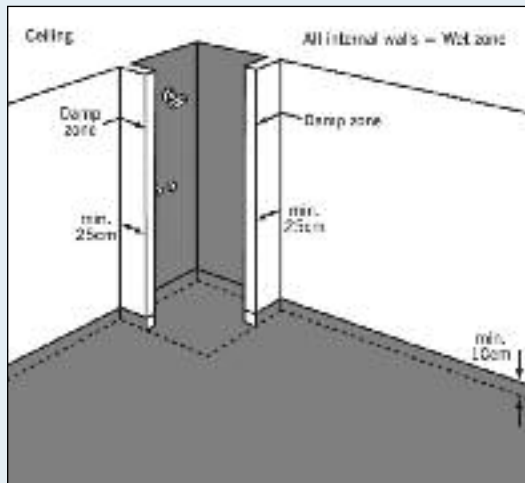

fig 2

If a shower attachment is fitted, the area around the basin should be treated from the floor upwards with a 50cm margin above and beside. Again, the whole floor should be treated as a wet zone whether the shower is fitted or not, with a 10cm upstand all the way round the walls.

See fig 3.

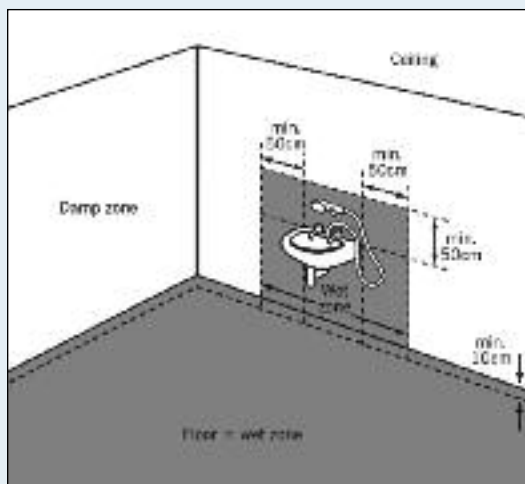

fig 3

walls and floors

Walls

All absorbent surfaces such as plasterboard, fibreboard and brickwork should be primed with one coat of Mira 4180 sealer used concentrated or diluted with water 1:3, depending on porosity of substrate.

- 1 Firstly cover all joints, edges and corners with 10cm wide Safecoat strips as explained on pages 31/32. **See fig 1.**
- 2 Using a brush or roller, apply a minimum of 1mm (1.25 kg/m²) Mira 4400 Multicoat to the surface. If applying in two stages the first coat must be dry before the next is applied. **See fig 2.**
- 3 The drying time for the waterproofing will depend on the room temperature and humidity. As a guide, allow approximately 1-2 hours for the sealer, 12 hours for the Multicoat to dry.



fig 1



fig 2

Floors

Prime all cement-based and absorbent surfaces with one coat of Mira 4180 sealer diluted with water 1:3. Wooden surfaces should be primed with sealer undiluted.

- 1 Coat the floor using a brush or roller with Mira 4400 Multicoat and simultaneously cover with Safecoat, rolling the material into the wet Multicoat ensuring an overlap on each run of at least 100mm. **See fig 1.**
- 2 A second coat of Mira 4400 Multicoat should be applied immediately to the Safecoat making sure that the material is fully covered and saturated. To check for complete waterproofing of the surface ensure that no trace of the white Safecoat is visible. **See fig 2.**
- 3 Allow approximately 12 hours for the Multicoat to dry before any further work is carried out. When completely dry the surface is ready to tile.



fig 1



fig 2

How to waterproof Dukkaboard® pipes

Pipes

Complete the following steps in quick succession:

- 1 Using the Safecoat manchet 5465 or 5470 (depending on the size of pipe), cut a hole out of the middle. **See fig 1.**
- 2 This should be slightly smaller than the diameter of the pipe. **See fig 2.**
- 3 Expose the self-adhesive backing, taking care not to let the manchet stick to itself. **See fig 3.**
- 4 Push over the pipe and onto the **Dukkaboard®**. **See fig 4.**
- 5 Make sure it is properly stuck to the board. **See fig 5.**
- 6 Apply a coat of Multicoat to the manchet and let dry. This will create a seal around the pipe. **See fig 6.**



Multicoat and Safecoat

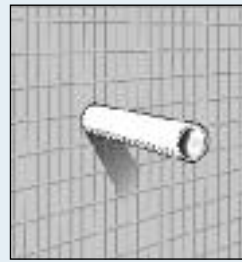

Before installation



fig 1

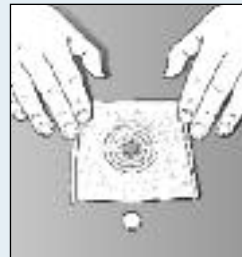

fig 2



fig 3

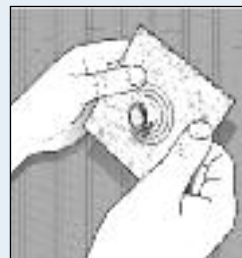

fig 4

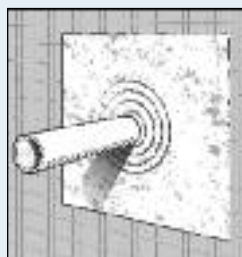
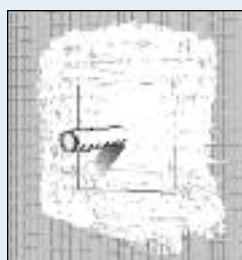

fig 5



fig 6



After installation

joints and washers

Joints

Complete the following steps in quick succession:

- 1 Apply the Multicoat to the surface of the boards with a paint brush or roller. **See fig 1.**
- 2 Stick the Safecoat strip onto the wet Multicoat making sure it is thoroughly adhered to the surface. **See fig 2.**
- 3 Paint a coat of Multicoat onto the Safecoat using a brush or roller to smooth out any creases. **See fig 3.**
- 4 Leave to dry before tiling. **See fig 4.**



Multicoat and Safecoat

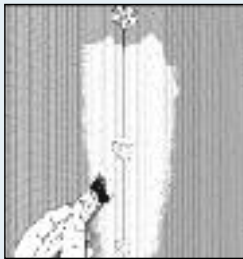

fig 1

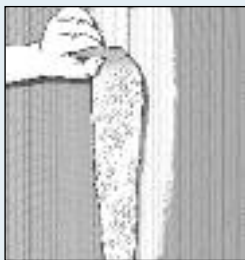

fig 2

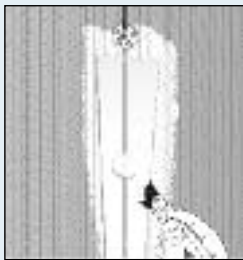

fig 3

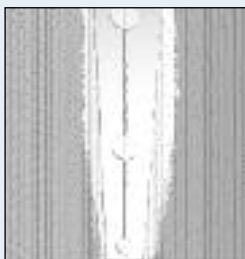

fig 4

Washers

Complete the following steps in quick succession:

- 1 Apply a coat of Multicoat to the fixing washer. **See fig 1.**
- 2 Apply Multicoat to the surrounding area using a brush or roller. **See fig 2.**
- 3 Cut a piece of Safecoat from a 10cm wide strip to create a square. **See fig 3.**
- 4 Press the Safecoat onto the wet Multicoat using the brush or roller and push into position and smooth out if necessary. **See fig 4.**
- 5 Paint a coat of Multicoat over the top to create a waterproof seal and leave to dry. **See fig 5.**



Multicoat and Safecoat



fig 1



fig 2



fig 3



fig 4

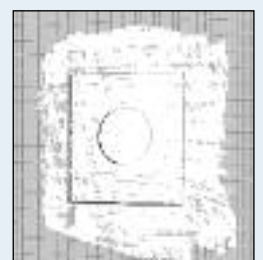

fig 5

How to waterproof Dukkaboard® corners

Corners

The following procedure should be carried out in quick succession:

- 1 Apply the Multicoat to the floor/wall joint with a brush or small roller, making sure the surface covered is at least 25mm wider than the Safecoat. **See fig 1.**
- 2 Lay the Safecoat onto the wet Multicoat. Push the Safecoat well into the corner and overlap it equally onto the wall and floor. Then reapply Multicoat. **See fig 2.**
- 3 To wrap the Safecoat around an internal corner, cut through to the middle of the material at exactly the right position. **See fig 3.**
- 4 Press the Safecoat onto the wet Multicoat, keeping the section for the floor off the surface. **See fig 4.**
- 5 Recoat this section with Multicoat and then stick the Safecoat to the floor. **See fig 5.**
- 6 Recoat the Safecoat with another coat of Multicoat and leave to dry. **See fig 6.**
- 7 Coat the vertical joints with Multicoat. **See fig 7.**
- 8 Apply the Safecoat to the area, pushing it well into the joint and making sure it doesn't quite meet the floor. **See fig 8.**
- 9 Recoat the Safecoat with another coat of Multicoat. **See fig 9.**



Multicoat and Safecoat

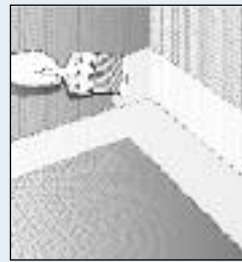

fig 1



fig 2



fig 3

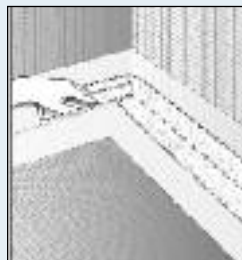

fig 4

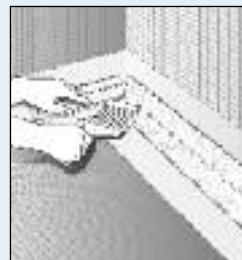

fig 5



fig 6

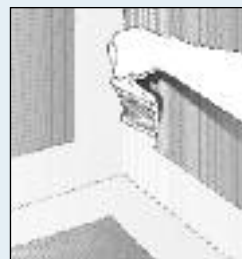

fig 7

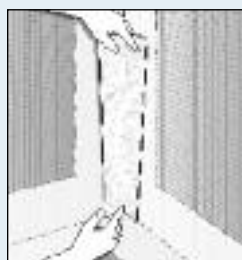

fig 8

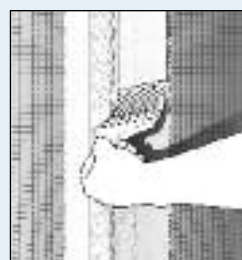

fig 9

Dukkaboard® specifications

Dukkaboard® Building Panels

An extensive range of flat panels for walls and floors in thicknesses from 4mm to 50mm.

Dukkaboard® building panels create the ultimate substrate. They can be fixed directly to timber or metal studwork instead of plasterboard. They can also be used to replace ply for strengthening floors or to cover old tiles and plaster instead of removing the 'old surface' and replastering. *Dukkaboard®* is the only backerboard you will ever need.

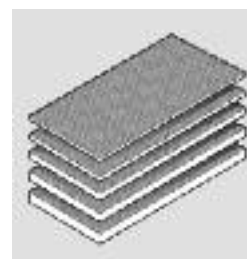

Dukkaboard®	Pallet Qty	Stock No
600 x 1300 x 4mm	140	5034
600 x 1300 x 6mm	140	5036
600 x 1300 x 10mm	100	5037
600 x 1300 x 12mm	80	5038
600 x 1300 x 20mm	50	5039
600 x 2600 x 10mm	100	5040
600 x 2600 x 20mm	50	5042
600 x 2600 x 30mm	36	5044
600 x 2600 x 40mm	30	5046
600 x 2600 x 50mm	26	5050
1200 x 2600 x 12mm	40	5052

Dukkaboard® Construct

These are pre-formed shower trays in a range of shapes and sizes including round and spiral shower kits.

Shower Trays – Horizontal Drain	Stock No
Square 900 x 900mm	5056
Oblong 1200 x 900mm	5058
Square 1200 x 1200mm	5061
Circular 1160mm diameter	5066
Quadrant 1000 x 1000mm	5067
Pentagon 1250 x 1250mm	5068

Shower Trays – Vertical Drain	Stock No
Square 900 x 900mm	5076
Square 1200 x 1200mm	5078
Oblong 1200 x 900mm	5077
Circular 1160mm diameter	5079
Quadrant 1000 x 1000mm	5080
Pentagon 1250 x 1250mm	5081



Made-to-Measure Shower Trays

Dukkaboard® Construct shower trays can be tailor-made to suit any application subject to a delivery time of three weeks. We can manufacture any size or non-standard shape you require up to 1750 x 1750mm. The drain outlet can be placed in any position. They are all available by special order.

Dukkaboard® specifications

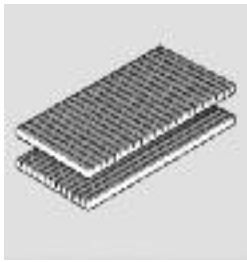

Dukkaboard® Creative

Dukkaboard® Creative pre-scored panels open up a whole new range of possibilities. They create walls and partitions of any shape and design in minutes. This eliminates expensive labour costs and provides the ultimate substrate ready for both tile fixing or render finishes.









The panels can be curved in either direction providing tight curves for pipes and columns or a gentle curve for shower enclosures, reception desks and counters. Dukkaboard® Creative coupled with imagination can produce the most amazing effects.

Dukkaboard® Creative

Shortscore	Pallet Qty	Stock No
600 x 1300 x 30mm	72	5187
600 x 1300 x 50mm	52	5182
Longscore	Pallet Qty	Stock No
2600 x 600 x 30mm	36	5188
2600 x 600 x 50mm	26	5189

Dukkaboard® Accessories

Dukkaboard® comes complete with an extensive range of accessories for efficient installation.

Description	Stock No	Description	Stock No
 Fixing Washers – pk100	5160	 Self Adhesive Waterproof Joint Tape 75mm x 10m	5175
 Fixing Dowel Stainless Steel 50mm 90mm 110mm	5161 5162 5163	 Reinforcement Mesh 1m x 50m	5185
 Joint Reinforcement Tape 100mm x 45m	5184	 U Mounting Bracket (30mm) (50mm)	5176 5178
 Waterproof Joint Tape 100mm x 50m	5174	 H Mounting Bracket (30mm) (50mm)	5177 5179

Dukkaboard® fixing details

floors

- timber**
- Drywall screws and fixing washers should be fixed at 300mm centres
See figs 1 and 2
 - Stagger all joints
 - Reinforce all joints with reinforcement tape unless waterproofing

- solid**
- Use a flexible, cement-based tile adhesive (C2 grade) and apply with an 8mm (minimum) notched trowel
 - Stagger all joints
 - Reinforce all joints with reinforcement tape unless waterproofing

walls

- stud**
- Fix boards using drywall screws and fixing washers at 300mm centres ensuring edges of boards always land on a stud
 - Stud centres **See figs 1 and 2**

300mm	12mm minimum
400mm	12mm minimum
600mm	20mm minimum

- solid smooth**
- Use a flexible, cement-based tile adhesive (C2 grade) and apply with an 8mm (minimum) notched trowel
 - Use 14 mechanical fixings (screws and fixing washers or fixing dowels) per 2600 x 600mm board and 8 per 1300 x 600mm board **See figs 3 and 4**
 - Reinforce all joints with reinforcement tape unless waterproofing

- solid rough**
- Use 20mm Dukkaboard minimum
 - Use dab and dowel method with flexible, cement-based tile adhesive (C2 grade) and fixing dowels
 - Use 14 mechanical fixings (screws and fixing washers or fixing dowels) per 2600 x 600mm board and 8 per 1300 x 600mm board **See figs 3 and 4**
 - Reinforce all joints with reinforcement tape unless waterproofing

Placement of screws and fixings



fig 1 1300 x 600mm with 300mm centres



fig 2 2600 x 600mm with 300mm centres



fig 3 1300 x 600mm with 8 washers



fig 4 2600 x 600mm with 14 washers

Dukkaboard® cutting methods

Dukkaboard® is lightweight and easy to cut using a number of different tools.



Craft Knife (for use on Dukkaboard® up to 20mm thickness)

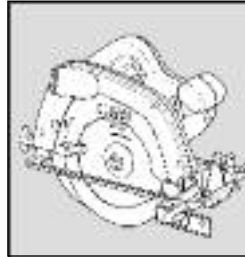

Circular Saw

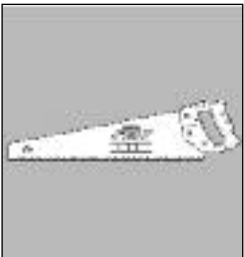

Hardpoint Saw

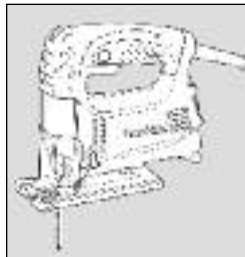

Jig Saw

Dukkaboard® technical details

Dukkaboard® Technical Details

Test standard for XPS centre	DIN EN 13164	
Compressive strength	DIN EN 1606	0.25N/mm ²
Thermal conductivity	DIN EN 13184	0.03W/m.k
Water absorption	DIN EN 12087	0.3% by vol
Flame resistance	DIN 4102	Class B1 (not readily ignitable)
Coefficient of linear expansion	DIN 53752	0.07mm/m.k
Maximum service temperature		-50/+75°C
Shear strength mortar/XPS @ 900 to board	DIN EN 12090	0.20N/mm ²
Tensile strength	DIN EN 1607	0.45N/mm ²
U values	6mm	3.383W/m ² K
	10mm	2.528W/m ² K
	12mm	2.247W/m ² K
	20mm	1.549W/m ² K
	30mm	1.117W/m ² K
	40mm	0.873W/m ² K
	50mm	0.717W/m ² K

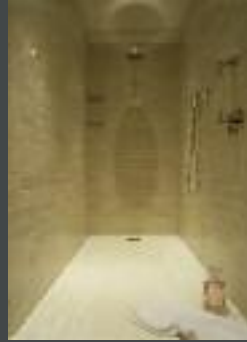

We reserve the right to amend product specifications without prior notice. The information, fixing details and technical instructions included in this literature are given in good faith. Recommendations for use should be verified as to the suitability and compliance with actual requirements, specifications and any applicable laws and regulations.



Dukkaboard®

use your imagination

Stockist

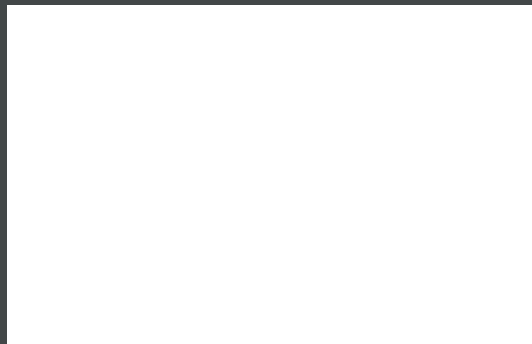

www.dukkaboard.com
Technical Helpline: 08701 271300